



## HK3024-2RS

Drawn cup needle roller bearing open end

Schaeffler ID:  
0013958740968

Drawn cup needle roller bearings with open ends HK..-2RS, lip seals on both sides, to DIN 618

### Technical information

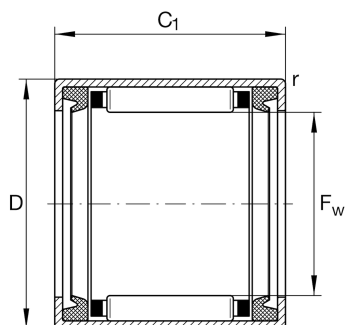

#### Main Dimensions & Performance Data

$F_w$	30 mm	Under roller diameter
$D$	37 mm	Outside diameter
$C$	24 mm	Width
$C_r$	22,000 N	Basic dynamic load rating, radial
$C_{0r}$	39,500 N	Basic static load rating, radial
$C_{ur}$	5,100 N	Fatigue load limit, radial
$n_G$	5,200 1/min	Limiting speed
$n_{G \text{ Grease}}$	5,200 1/min	Limiting speed for grease lubrication
	44.945 g	Weight

#### Dimensions

$C_1$	24 mm	Width, outer ring
$r_{\min}$	0.8 mm	Minimum chamfer dimension

#### Temperature range

$T_{\min}$	-20 °C	Operating temperature min.
$T_{\max}$	100 °C	Operating temperature max.